

OCV CONTROL VALVES

- ◆ **MULTIPLE PRESSURE AND FLOW CONTROL FUNCTIONS IN ONE VALVE**
- ◆ **SIMPLE DESIGN, RELIABLE PERFORMANCE**
- ◆ **ROBUST HEAVY DUTY CONSTRUCTION**
- ◆ **EASILY SERVICED INSITU**
- ◆ **VARIETY OF BODY MATERIALS AVAILABLE**
- ◆ **1.1/4 INCH TO 24 INCH SIZES AVAILABLE**
- ◆ **5 YEAR WARRANTY**



About OCV

OCV Control Valves is a worldwide industry leader in designing hydraulically-operated, diaphragm-actuated, automatic control valves. They deliver the highest quality valves to a range of industries, including Waterworks, Fire Protection, Commercial Plumbing and Fuel Handling. Aljac now distributes the OCV Valve for the fuels handling sector.

Description

The OCV 65 Series Basic Globe Valve and 65 Series Basic Angle Valve are full port engineered valves. When equipped with a variety of pilots and accessories the valves perform a wide range of automatic fluid control functions. The 65 Series valve is reliable and hard working, with a simplicity of design that ensures minimal wear for exceptional performance and longevity, and comes with a 5 year warranty (subject to OCV Terms and Conditions). It consists of only three major components, the body, bonnet and diaphragm assembly. The 65 Series valve is self contained and operates automatically using line pressure and can be fully overhauled without removing it from the pipeline.

Major Components

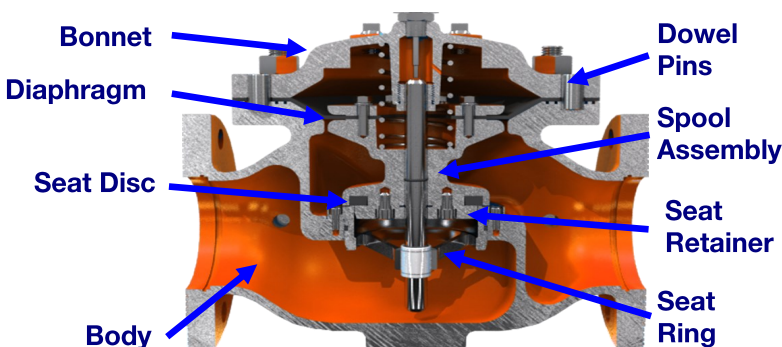

Mode Of Operation

The valve status is determined by controlling the pressure above the diaphragm, and this sets the spool/seat position.

Valve Closed

Upstream Pilot open, Downstream Pilot closed. Valve inlet pressure is applied to the cover chamber, pressuring the diaphragm. The valve is closed drip-tight.

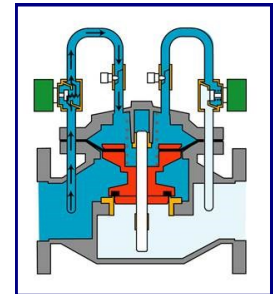

Valve Open

Upstream Pilot closed, Downstream Pilot open. Valve cover chamber pressure is vented downstream. The valve is fully open.

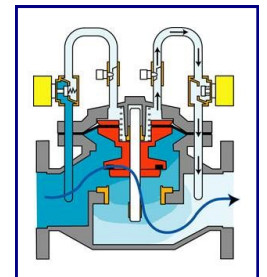

Valve Modulating

When the valve is between fully open and fully closed, the valve's control pilots modulate the pressure in the cover chamber, positioning the valve to control the desired flow properties (depending on which particular control pilots are installed).

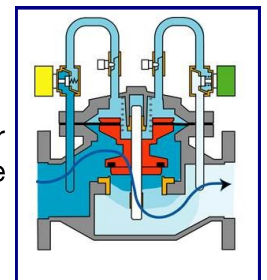

Available Functions

Position Indicator/Limit Switches: Allows the Valve open/closed status (stem position) to be visually observed and provide external control signals.

Manual Override: Ball valves are installed in the control pilot system to manually override the main Valve functions.

Rate Of Flow Control: The Valve controls the system flow rate to an adjustable pre-set value.

Single Stage On/Off: A solenoid is fitted which allows the Valve to be opened and closed from a remote location (voltage to be specified).

Digital Control: Two solenoids are fitted which allow the Valve to control the system flow rate and open/closed status (voltage to be specified). This is used in conjunction with digital metering systems.

Two Stage Preset: Two solenoids are fitted which react to signals from a flow meter preset register. The Valve opens in one stage and closes in two stages to reduce system pressure surges.

Pressure Reducing/Control: The Valve controls the maximum downstream pressure to an adjustable pre-set value despite varying upstream pressure conditions.

Differential Pressure Control: The Valve operates on/off to control the differential pressure between two points in the system. This is commonly used as an air eliminator shut off valve in flow metering systems.

Non Surge Check: The Valve opens at an adjustable speed to minimise surge pressures during pump start up and closes quickly to prevent reverse flow on pump shut down.

Tank Level Control: The Valve is used in conjunction with a remote float pilot to shut off flow into a tank when a high level is reached.

Pressure Relief/Sustaining: The Valve opens to relieve an excessive upstream pressure (Pressure Relief) or closes to prevent the upstream pressure falling below a pre-determined level (Pressure Sustaining).

Deadman Control: The Valve opens and closes in response to a signal from an electric, hydraulic or pneumatic 'deadman' control system. This is commonly used on truck loading stands.

Filter Water Separator Discharge Control: The Valve opens and closes in response to a float pilot fitted to the filter vessel to prevent discharge of a water slug into the downstream fuel system.

Multiple combinations of the above functions can be fitted to a single valve, for example, Rate Of Flow Control, Pressure Reducing and Non Surge Check functions can be combined.

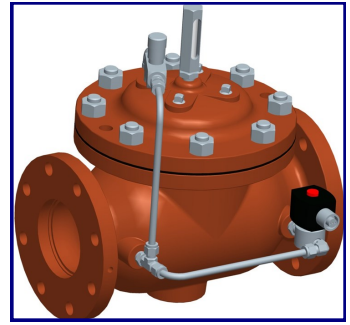

Single Stage On/Off

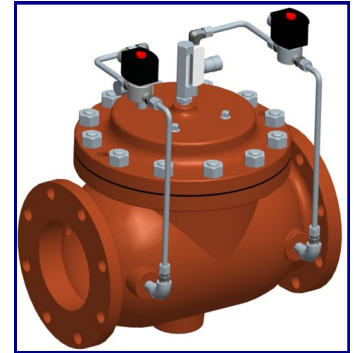

Digital Control



Two Stage Preset with Rate of Flow Control

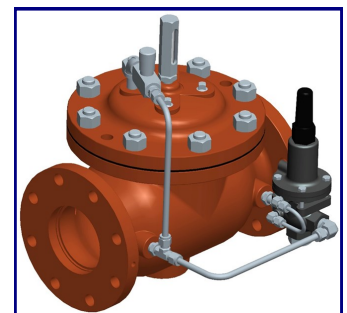

Pressure Reducing/Control

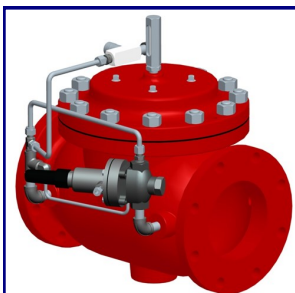

Differential Pressure Control

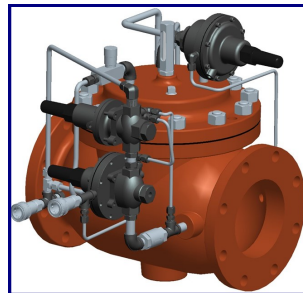

Hydraulic Deadman and Pressure Control

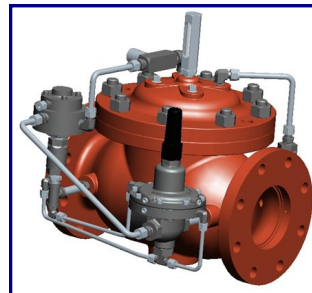

FWS Discharge Control

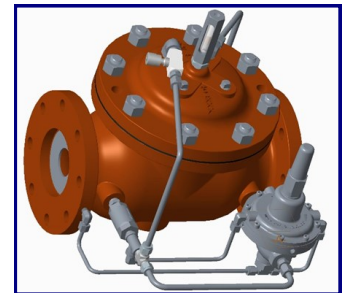

Non Surge Check with Rate of Flow Control

Valve Configurations



GLOBE PATTERN.
FLANGED: 1.1/4 inch to 24 inch.
THREADED: 1.1/4 inch to 3 inch.



ANGLE PATTERN.
FLANGED: 1.1/4 inch to 16 inch.
THREADED: 1.1/4 inch to 3 inch.

Dimensions

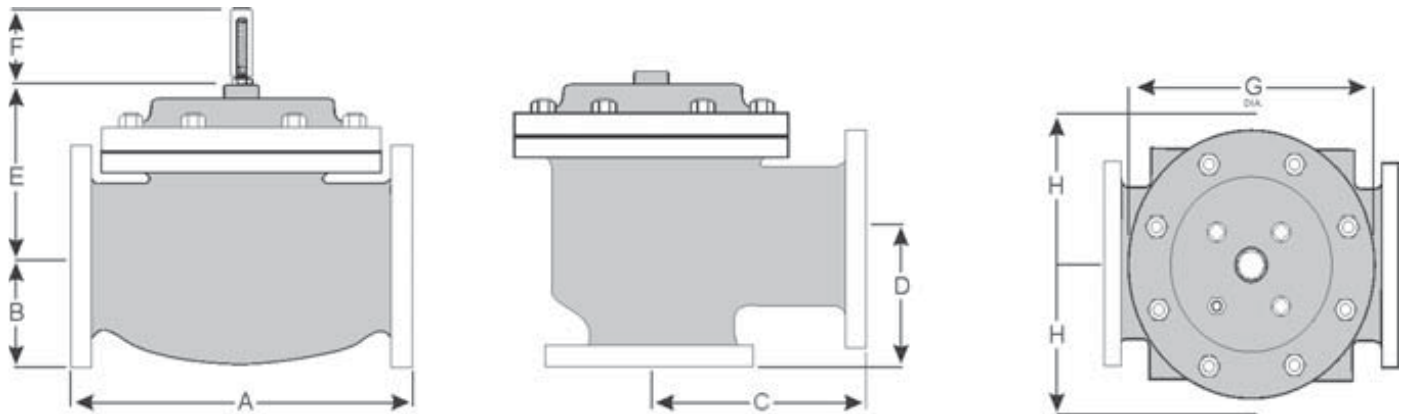

| Dim. MM | End Connection | 1.1/4 to 1.1/2 inch | 2 inch | 2.1/2 inch | 3 inch | 4 inch | 6 inch | 8 inch | 10 inch | 12 inch | 14 inch | 16 inch | 24 inch |
|----------|----------------|---------------------|--------|------------|--------|--------|--------|--------|---------|---------|---------|---------|---------|
| A | Threaded | 222 | 251 | 257 | 330 | N/A | N/A | N/A | N/A | N/A | N/A | N/A | N/A |
| | Flanged 150lb | 216 | 238 | 267 | 305 | 381 | 451 | 645 | 756 | 864 | 991 | 1026 | 1575 |
| | Flanged 300lb | 222 | 251 | 283 | 324 | 397 | 473 | 670 | 791 | 902 | 1029 | 1067 | 1619 |
| B | Threaded | 37 | 43 | 48 | 57 | N/A | N/A | N/A | N/A | N/A | N/A | N/A | N/A |
| | Flanged 150lb | 59-64 | 76 | 89 | 95 | 114 | 140 | 171 | 203 | 241 | 270 | 298 | 406 |
| | Flanged 300lb | 67-78 | 83 | 95 | 105 | 127 | 159 | 191 | 222 | 260 | 292 | 324 | 457 |
| C | Threaded | 111 | 121 | 152 | 165 | N/A | N/A | N/A | N/A | N/A | N/A | N/A | N/A |
| | Flanged 150lb | 108 | 121 | 152 | 152 | 191 | 254 | 322 | 378 | 432 | N/A | 529 | n/A |
| | Flanged 300lb | 111 | 127 | 162 | 162 | 198 | 267 | 335 | 395 | 451 | N/A | 549 | N/A |
| D | Threaded | 79 | 98 | 102 | 114 | N/A | N/A | N/A | N/A | N/A | N/A | N/A | N/A |
| | Flanged 150lb | 76 | 98 | 102 | 102 | 140 | 152 | 203 | 289 | 279 | N/A | 398 | N/A |
| | Flanged 300lb | 79 | 105 | 111 | 111 | 148 | 165 | 216 | 306 | 298 | N/A | 419 | N/A |
| E | All | 152 | 152 | 178 | 165 | 203 | 254 | 302 | 391 | 432 | 457 | 483 | 686 |
| F | All | 98 | 98 | 98 | 98 | 98 | 98 | 162 | 162 | 162 | 162 | 162 | 203 |
| G | All | 152 | 171 | 195 | 222 | 298 | 356 | 533 | 622 | 711 | 794 | 876 | 1321 |
| H | All | 254 | 279 | 279 | 279 | 305 | 330 | 356 | 432 | 457 | 508 | 508 | 724 |

Typical Applications

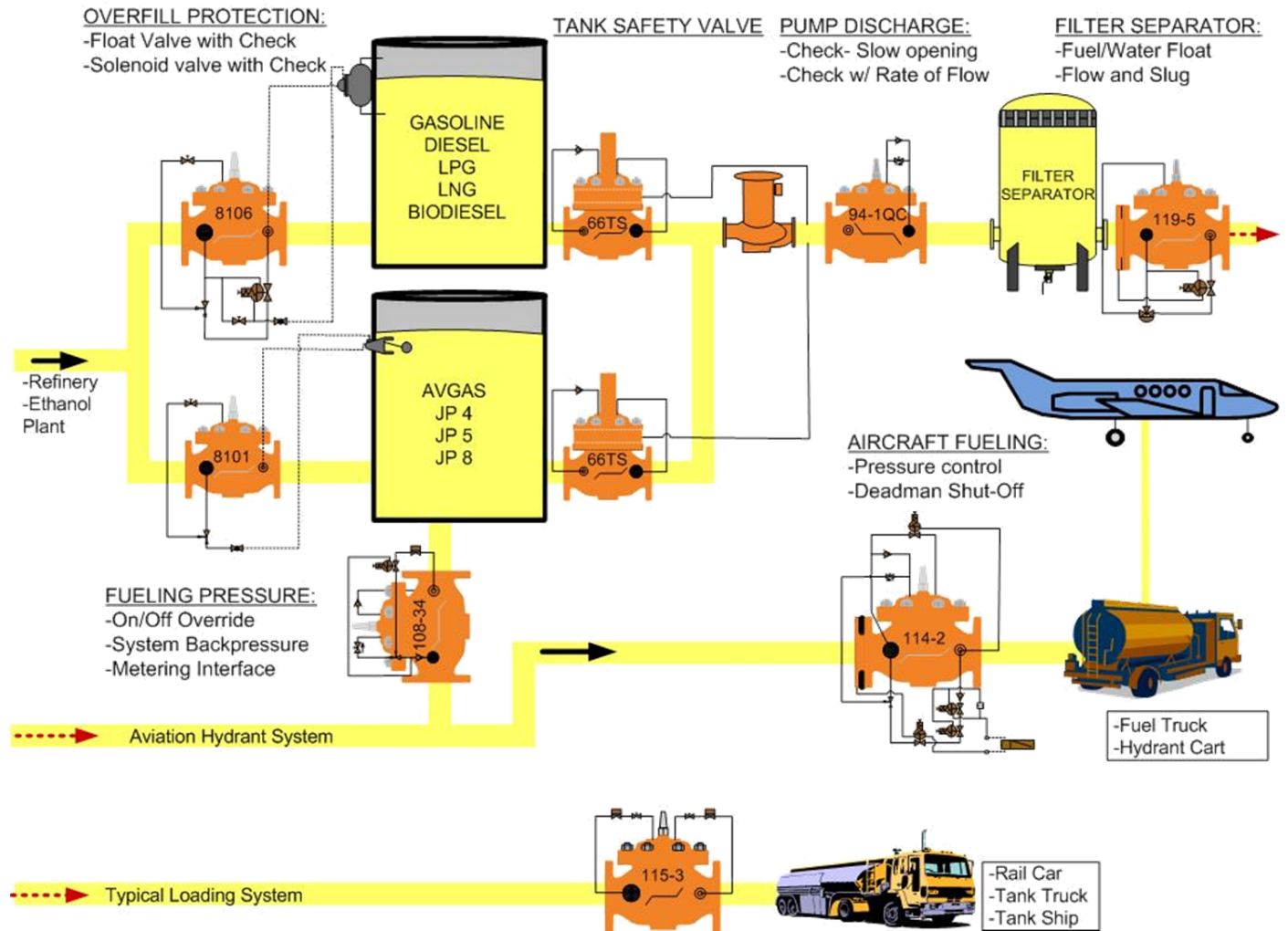

Material Of Construction

Body/Bonnet: Carbon Steel ASTM A216WCB (Epoxy coated), Stainless Steel (all grades), or Aluminium.

Stem: Stainless Steel.

Spring: Stainless Steel.

Seat Ring: Stainless Steel.

Diaphragm: Viton (Nylon Reinforced).

Seals: Viton.

Control Pilot Valves: Stainless Steel.

Control Pilot Valve Pipework: Stainless Steel.

Operating Parameters

Maximum Working Pressure:

Threaded. 44.0 Bar.

Flanged ANSI B16.5 150lb. 19.6 Bar.

Flanged ANSI B16.5 300lb. 51.0 Bar.

Maximum Operating Temperature: 110°C.

How To Order

Contact the Aljac Sales Department and specify the following:

Fluid.

Valve Size.

Body Material.

Angle or Inline pattern.

Required end connections.

Functions (Control Pilot options).

Required set points.

System operating parameters (flow rate and pressure).